



IMPACT

Features and Benefits

- Standard Color – light gray with a high gloss finish
- Best material – bases, opaque covers and clear covers are all made of high-impact, UV resistant polycarbonate
- Easy ordering – One part number equals one completely assembled enclosure
- Super easy use – mounting flanges integral, so no extra hardware needed
- Flexible interior Mounting – bosses on rear wall and lid of opaque enclosure provide multiple mounting options for din rail, back panels, or other components
- Advanced face plate mounting system – Brand new completely unique and easy
- Secure – Choose your level of protection: pad lockable, tamper screw or tamper tag capable
- Frequency Friendly – Available with absolutely no metals of any kind on the enclosure which is extremely favorable for sending and receiving wireless signals
- UL-50 / c-UL Listed (file # E207562)

Our Impact Line enclosures are the most versatile, feature packed, aesthetically pleasing, Nema UL rated, non-metallic enclosures available. Features like extremely durable, UV resistant, wide temperature range, easy to machine, lighter than other non-metallic or metal materials, the “Made in USA” Impact Line enclosures provide great value to any application.



Mechanical and Thermal	Test Spec.	Unit	Impact Line
Instrumented Dart Impact @ 73° F		in/lb.	565
Falling Ball Impact @ 73° F	UL-746	in/lb.	900
Deflection Temperature @ 264 psi	ASTM D648	Deg. F	270
Modulus of Elasticity	ASTM D790	ksi	340
Temperature Range		Deg. F	-40 to 265

Flammable / UV Ratings	Test Spec.	Unit	Impact Line
Flame Rating - UL	UL 94	-	5VA
Outdoor UV Exposure	UL	-	f1



Atex pending contact factory for details

P10086	4X IP66	6P IP68	Clear Cover	Opaque Cover	Integrated Mounting Flange	Standard Hinge	Low Profile Hinge	Integrated Locking Latch	Stainless Steel Locking Latch	Non-Metallic Locking Latch	T-Rail Mtg System
P10086	✓	✓		✓	✓	✓		✓		✓	✓
P10086C	✓	✓	✓		✓	✓		✓		✓	✓
P10086LL	✓			✓	✓	✓			✓	✓	✓
P10086CLL	✓		✓		✓	✓			✓	✓	✓
P10086LP	✓	✓		✓	✓		✓	✓		✓	✓
P10086LPC	✓	✓	✓		✓		✓	✓		✓	✓
P10086LPLL	✓			✓	✓		✓		✓	✓	✓
P10086LPCLL	✓		✓		✓		✓		✓	✓	✓
P10086NL	✓			✓	✓	✓				✓	✓
P10086CNL	✓		✓		✓	✓				✓	✓
P10086LPNL	✓			✓	✓		✓			✓	✓
P10086LPCNL	✓		✓		✓		✓			✓	✓

* Sold separately





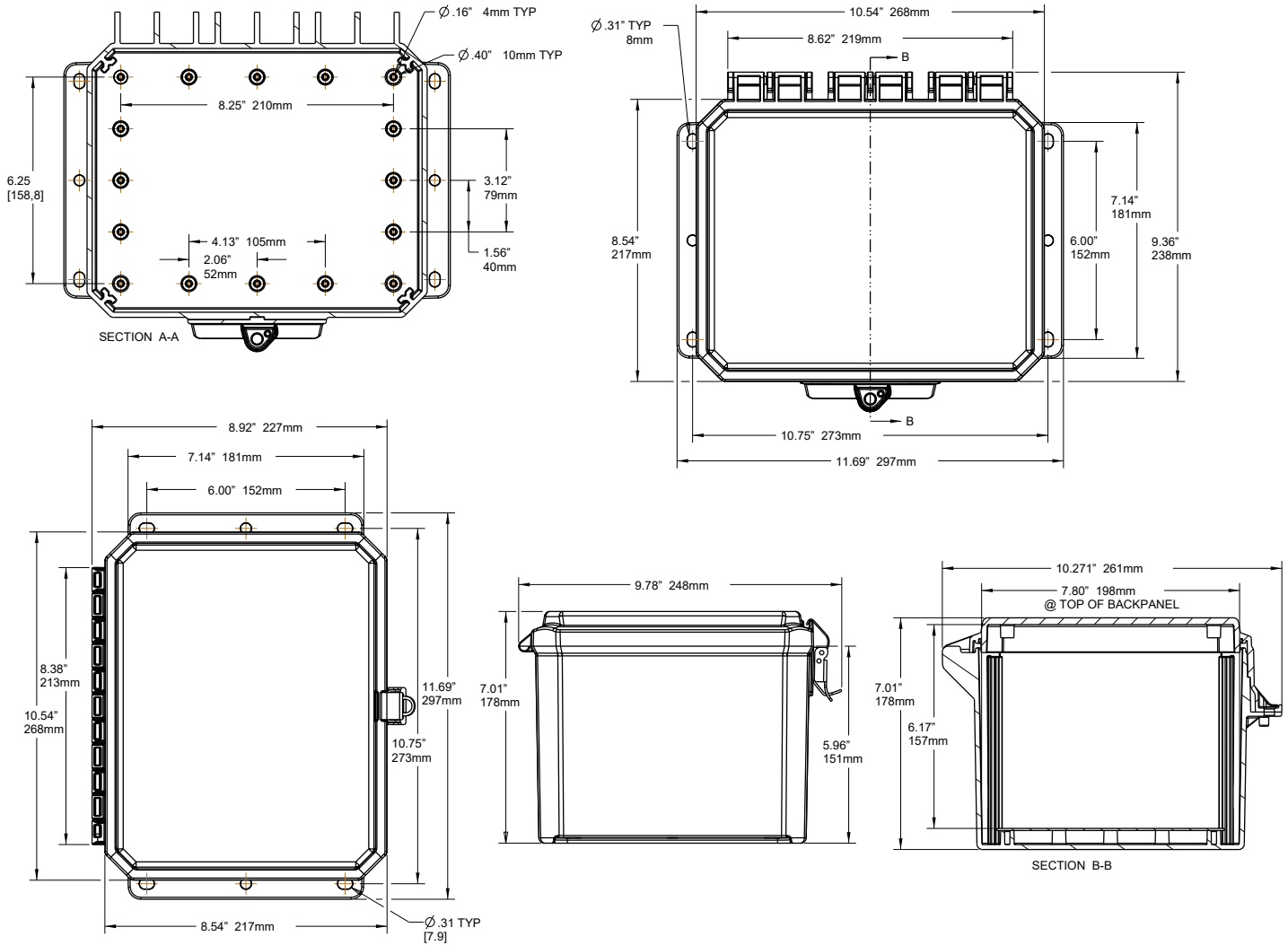





10X8X6 IMPACT LINE



Register online to download this drawing off the Integra website at www.integraenclosures.com | Your company's logo or other information on the lid. Consult factory for details.

Accessories for 10x8x6 Impact (For complete accessories, see page 52-54)

	<p>Back Panels ABP108-IMP - Aluminum panel SBP108-IMP - Steel panel PVCBP108-IMP - PVC panel</p>		<p>Aluminum Swing Out Panels ABP-108USP/USOPK - Complete panel kit ABP-108USP - Aluminum swing out panels only USOPK - Hardware only</p>		<p>Back Panel Adjustment Kit BPAKG - Gray, Set Screw BPAKB - Black, Set Screw UBPAKG - Gray, Thumb Screw UBPAKB - Black Thumb Screw</p>
	<p>Air Vents VENT 3 - Aluminum louvered VENT 2 - Outdoor labyrinth</p>		<p>Steel Swing Out Panels SBP-108USP/USOPK - Complete panel kit SBP-108USP - Steel swing out panels only USOPK - Hardware only</p>		<p>Mounting Screws SP-8 - 10 Pieces self-tapping screws for bosses</p>
	<p>Din Rail DIN 8-IMP - 2 rails, 4 screws</p>		<p>Pole Mounting Kit PMKG-28-IMP - 2" pole PMKG-38-IMP - 3" pole PMKG-48-IMP - 4" pole PMKG-128-IMP - 12" pole</p>		<p>Cord Grips IP68/NEMA 4X/6P rated See page 53 for more details.</p>