

8X6X3 IMPACT® SERIES



Features & Benefits

- **Quality material** – bases, opaque covers and clear covers are all made of high-impact, UV resistant polycarbonate.
- **Frequency friendly** – 100% metal free configurations available which is extremely favorable for sending and receiving wireless signals.
- **Advanced face plate system** – bosses on rear wall and lid of opaque enclosure provide multiple mounting options for DIN rail, back panels, and other components.
- **Easy installation** – with molded mounting flanges, so no extra hardware is needed.
- **Flexible interior mounting** – bosses on rear wall and lid of opaque enclosure provide multiple mounting options for DIN rail, back panels, or other components.
- **Standard color** – light gray with a gloss finish.
- **UL-50 / c-UL Listed** (file # E207562)

Mechanical & Thermal	Test Spec.	Unit	Rating
Instrumented Dart Impact @ 73° F	-	in-lbs	565
Falling Ball Impact @ 73° F	UL-746	in-lbs	900
Deflection Temperature @ 264 psi	ASTM D648	Deg. F	270
Modulus of Elasticity	ASTM D790	ksi	340
Temperature Range	-	Deg. F	-40 to 265
Flame Rating - UL	UL 94	-	5VA
Outdoor UV Exposure	UL	-	F1



Part Number	4X IP66	6P IP68	Standard Hinge	Low Profile Hinge	Opaque Cover	Clear Cover	Integrated Mounting Flange	Integrated Locking Latch	Stainless Steel Locking Latch	Non-Metallic Locking Latch
★ P8063	✓	✓	✓		✓		✓	✓		
★ P8063C	✓	✓	✓			✓	✓	✓		
P8063LL	✓				✓		✓		✓	
P8063CLL	✓					✓	✓		✓	
P8063LP	✓	✓		✓	✓		✓	✓		
P8063LPC	✓	✓		✓		✓	✓	✓		
P8063LPLL	✓			✓	✓		✓		✓	
P8063LPCLL	✓			✓		✓	✓		✓	
P8063NL	✓		✓		✓		✓			✓
P8063CNL	✓		✓			✓	✓			✓
P8063LPNL	✓			✓	✓		✓			✓
P8063LPCNL	✓			✓		✓	✓			✓

★ **POPULAR CONFIGURATIONS:** Most popular configurations are available for *QuickShip*. Please send requests to customerservice@integraenclosures.com to take advantage of our *QuickShip* option.



8X6X3 IMPACT[®] SERIES

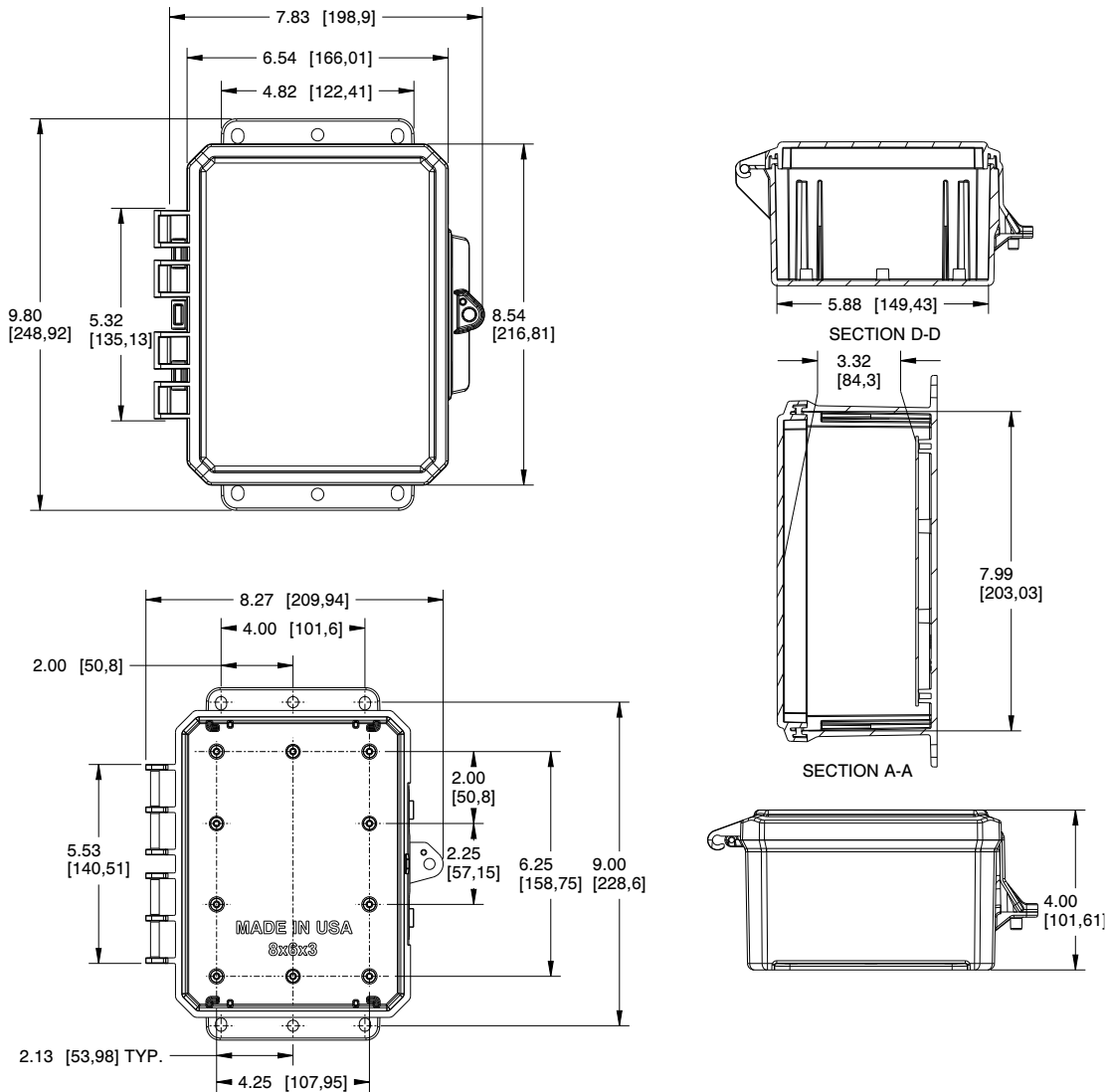









[Bracketed dimensions in mm]

TORQUE SPECIFICATIONS:

Panels - #8 thread cutter pan head 18-8 SS (torque limit = 8 in lbs)

Register online to download detailed drawing files at www.integraenclosures.com

Accessories for 8x6x3 (For complete accessories, see pages 86-89)

 <p>Back Panels ABP86-IMP - Aluminum panel SBP86-IMP - Steel panel PVCBP86-IMP - PVC panel</p>	 <p>Aluminum Swing Panel Kits ASWPK86-IMP - Aluminum swing panel and SOPK-IMP mounting kit ASWP86-IMP - Panel only SOPK66-86-IMP - Rigid brackets, pivot bracket & self-tapping screws</p>	 <p>Aluminum Face Plate System AFP86-IMP - Aluminum face plate and SOPK-IMP mounting kit AFP86-IMP - Panel only SOPK66-86-IMP - Rigid brackets, pivot bracket & self-tapping screws</p>
 <p>Air Vents VENT 3 - Aluminum louvered VENT 2 - Outdoor labyrinth</p>	 <p>Steel Swing Panel Kits SSWPK86-IMP - Steel swing panel and SOPK-IMP mounting kit SSWP86-IMP - Panel only SOPK66-86-IMP - Rigid brackets, pivot bracket & self-tapping screws</p>	 <p>Steel Face Plate System SFPK86-IMP - Steel face plate and SOPK-IMP mounting kit SFP86-IMP - Panel only SOPK66-86-IMP - Rigid brackets, pivot bracket & self-tapping screws</p>
 <p>Din Rail DIN 6-IMP - 2 rails, 4 screws</p>	 <p>Pole Mounting Kit PMKG-26-IMP - 2" pole PMKG-36-IMP - 3" pole PMKG-46-IMP - 4" pole PMKG-126-IMP - 12" pole</p>	 <p>Cord Grips IP68/NEMA 4X/6P rated See page 78 for more details.</p>