

20X16X8 GENESIS SERIES



Multi-Max Rails & Stiffener Frame
Not included with E part numbers

Features & Benefits

- **Quality material** – bases, opaque covers and clear covers are all made of high-impact, UV resistant polycarbonate.
- **Full hinge** – sturdy, full length piano hinged door
- **Multi-Max Rail Mounting System®** – maximize your enclosure space with full three-dimensional mounting capabilities.
- **Rigid construction** – unique, internal Multi-Max frame provides additional strength.
- **Extra mounting bosses** – brass inserts on rear wall of enclosure and on lid for more mounting options.
- **Integrated flange** – mounting flanges moulded into base, eliminating the need for extra hardware.
- **Multiple latch options** – non-metallic, quarter turn or three-point latch configurations
- **UL / c-UL-50 listed** (File # E207562)

Mechanical & Thermal	Test Spec.	Unit	Rating
Instrumented Dart Impact @ 73° F	-	in-lbs	565
Falling Ball Impact @ 73° F	UL-746	in-lbs	900
Deflection Temperature @ 264 psi	ASTM D648	Deg. F	270
Modulus of Elasticity	ASTM D790	ksi	340
Temperature Range	-	Deg. F	-40 to 265
Flame Rating - UL	UL 94	-	5VA
Outdoor UV Exposure	UL	-	F1



Part Number	4X IP66	6P IP68	Piano Hinge	Opaque Cover	Clear Cover	Integrated Mounting Flange	Non-Metallic Locking Latch	3-Point Latch	1/4 Turn Latch	Multi-Max Rail System
★ G201608	✓	✓	✓	✓		✓	✓			✓
★ G201608C	✓	✓	✓		✓	✓	✓			✓
G201608TPL	✓		✓	✓		✓		✓		✓
G201608CTPL	✓		✓		✓	✓		✓		✓
G201608QTL	✓		✓	✓		✓			✓	✓
G201608CQTL	✓		✓		✓	✓		✓		✓
G201608E	✓	✓	✓	✓		✓	✓			
G201608CE	✓	✓	✓		✓	✓	✓			

★ **POPULAR CONFIGURATIONS:** Most popular configurations are available for *QuickShip*. Please send requests to customerservice@integraenclosures.com to take advantage of our *QuickShip* option.



20X16X8 GENESIS SERIES

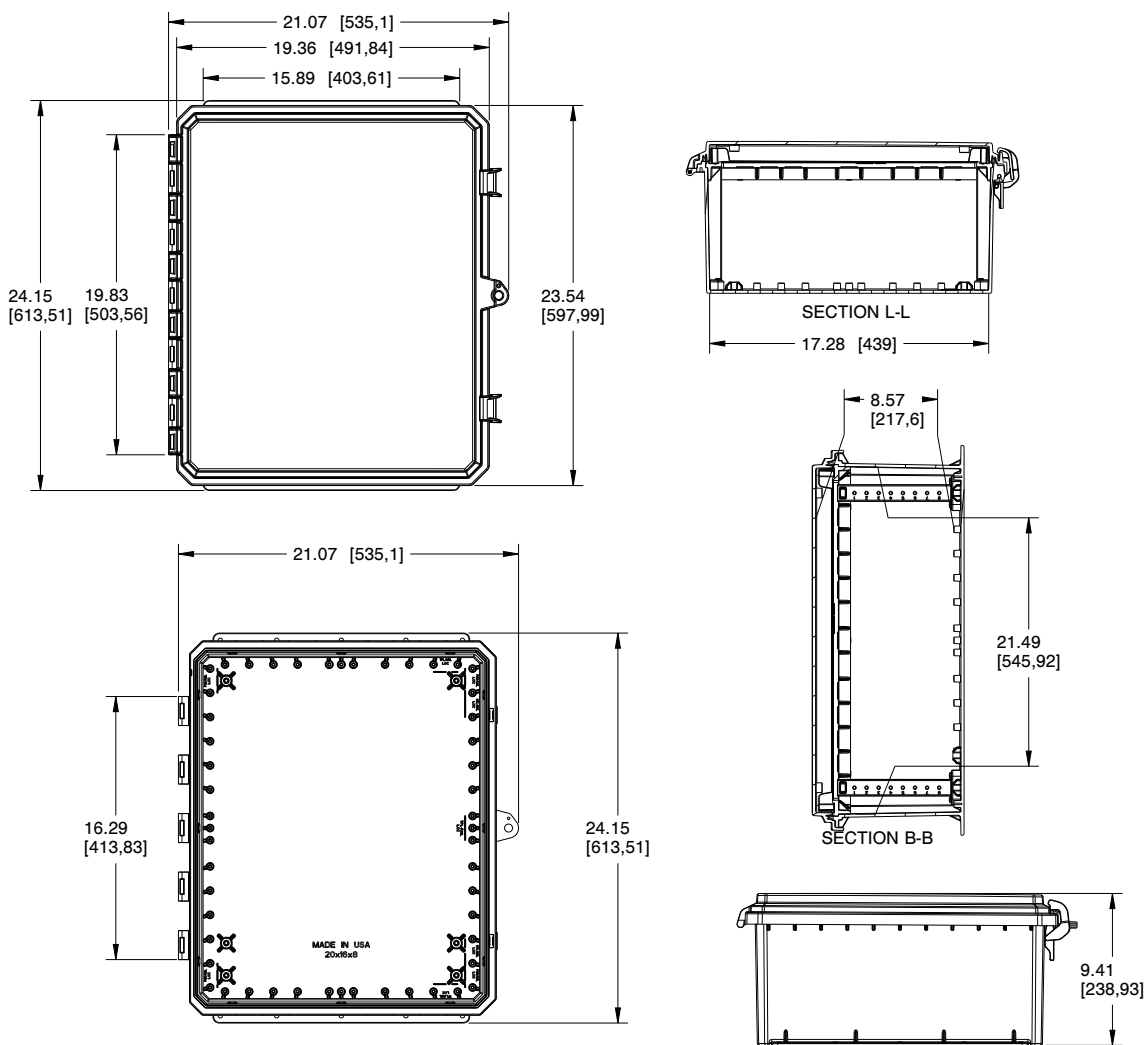

[Bracketed dimensions in mm]





TORQUE SPECIFICATIONS:

Mounting Feet - 1/4"-20 x 0.5" pan head 18-8 SS (torque limit = 32 in lbs)

Panels - 1/4"-20 x 0.5" pan head 18-8 SS (torque limit = 32 in lbs)

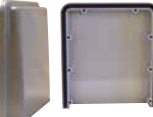
Register online to download detailed drawing files at www.integraenclosures.com

Accessories for 20x16x8 (For complete accessories, see pages 90-91)

 <p>Back Panels ABP-2016 - Aluminum panel SBP-2016 - Steel panel PVCBP-2016 - PVC panel</p>	 <p>Panel Pads KIT-GPP-2016 - Four panel pads and screws</p>	 <p>Self-Tapping Screws GSP-10 - Self-tapping screws for bosses (10 per pack)</p>
 <p>Fan Shroud Kits FS-KIT-1 - One shroud with gasket and screws FS-KIT-2 - Two shrouds with gasket and screws</p>	 <p>Swing Panel Kits ABP2016-GSOPK - Aluminum panel kit SBP2016-GSOPK - Steel panel kit GSOPK20 - 20" hinge, panel pads & screws</p>	 <p>Multi-Max Rails® KIT-GMMR8 - Four Multi-Max Rails® with screws included</p>
 <p>Door Stop Kit KIT-DOOR-STOP - Door Stop Kit for Genesis Enclosures</p>	 <p>Pole Mounting Kits PMKG-216-GEN - 2" pole PMKG-316-GEN - 3" pole PMKG-416-GEN - 4" pole PMKG-1216-GEN - 12" pole</p>	 <p>Multi-Max Frame GSR2016 - Multi-Max frame stiffener</p>