

# 6X6X3 IMPACT® SERIES



## Features & Benefits

- **Quality material** – bases, opaque covers and clear covers are all made of high-impact, UV resistant polycarbonate.
- **Frequency friendly** – 100% metal free configurations available which is extremely favorable for sending and receiving wireless signals.
- **Advanced face plate system** – bosses on rear wall and lid of opaque enclosure provide multiple mounting options for DIN rail, back panels, and other components.
- **Easy installation** – with molded mounting flanges, so no extra hardware is needed.
- **Flexible interior mounting** – bosses on rear wall and lid of opaque enclosure provide multiple mounting options for DIN rail, back panels, or other components.
- **Standard color** – light gray with a gloss finish.
- **UL-50 / c-UL Listed** (file # E207562)

Mechanical & Thermal	Test Spec.	Unit	Rating
Instrumented Dart Impact @ 73° F	-	in-lbs	565
Falling Ball Impact @ 73° F	UL-746	in-lbs	900
Deflection Temperature @ 264 psi	ASTM D648	Deg. F	270
Modulus of Elasticity	ASTM D790	ksi	340
Temperature Range	-	Deg. F	-40 to 265
Flame Rating - UL	UL 94	-	5VA
Outdoor UV Exposure	UL	-	F1



Part Number	4X IP66	6P IP68	Standard Hinge	Low Profile Hinge	Opaque Cover	Clear Cover	Integrated Mounting Flange	Integrated Locking Latch	Stainless Steel Locking Latch	Non-Metallic Locking Latch
★ P6063	✓	✓	✓		✓		✓	✓		
★ P6063C	✓	✓	✓			✓	✓	✓		
P6063LL	✓				✓		✓		✓	
P6063CLL	✓					✓	✓		✓	
P6063LP	✓	✓		✓	✓		✓	✓		
P6063LPC	✓	✓		✓		✓	✓	✓		
P6063LPLL	✓			✓	✓		✓		✓	
P6063LPCLL	✓			✓		✓	✓		✓	
P6063NL	✓		✓		✓		✓			✓
P6063CNL	✓		✓			✓	✓			✓
P6063LPNL	✓			✓	✓		✓			✓
P6063LPCNL	✓			✓		✓	✓			✓

★ **POPULAR CONFIGURATIONS:** Most popular configurations are available for *QuickShip*. Please send requests to [customerservice@integraenclosures.com](mailto:customerservice@integraenclosures.com) to take advantage of our *QuickShip* option.



# 6X6X3 IMPACT<sup>®</sup> SERIES

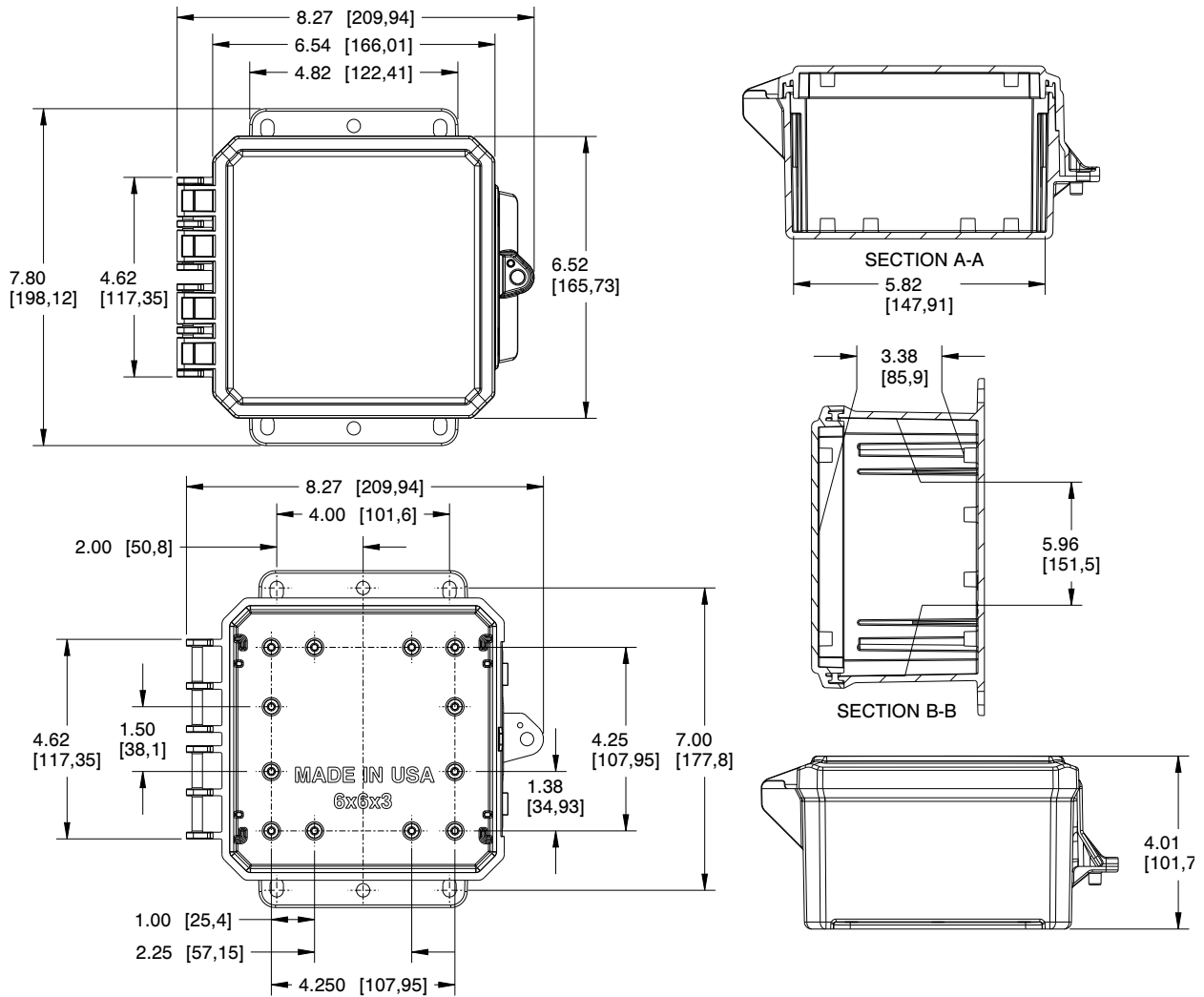







[Bracketed dimensions in mm]

## TORQUE SPECIFICATIONS:

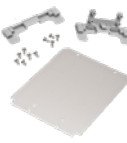
**Panels** - #8 thread cutter pan head 18-8 SS (torque limit = 8 in lbs)

Register online to download detailed drawing files at [www.integraenclosures.com](http://www.integraenclosures.com)

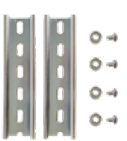
## Accessories for 6x6x3 (For complete accessories, see pages 86-89)

 <p><b>Back Panels</b>  <b>ABP66-IMP</b> - Aluminum panel  <b>SBP66-IMP</b> - Steel panel  <b>PVCBP66-IMP</b> - PVC panel</p>	 <p><b>Aluminum Swing Panel Kits</b>  <b>ASWPK66-IMP</b> - Aluminum swing panel and SOPK-IMP mounting kit  <b>ASWP66-IMP</b> - Panel only  <b>SOPK66-86-IMP</b> - Rigid brackets, pivot bracket &amp; self-tapping screws</p>	 <p><b>Aluminum Face Plate System</b>  <b>AFP66-IMP</b> - Aluminum face plate and SOPK-IMP mounting kit  <b>AFP66-IMP</b> - Panel only  <b>SOPK66-86-IMP</b> - Rigid brackets, pivot bracket &amp; self-tapping screws</p>
 <p><b>Air Vents</b>  <b>VENT 3</b> - Aluminum louvered  <b>VENT 2</b> - Outdoor labyrinth</p>	 <p><b>Steel Swing Panel Kits</b>  <b>SSWPK66-IMP</b> - Steel swing panel and SOPK-IMP mounting kit  <b>SSWP66-IMP</b> - Panel only  <b>SOPK66-86-IMP</b> - Rigid brackets, pivot bracket &amp; self-tapping screws</p>	 <p><b>Steel Face Plate System</b>  <b>SFPK66-IMP</b> - Steel face plate and SOPK-IMP mounting kit  <b>SFP66-IMP</b> - Panel only  <b>SOPK66-86-IMP</b> - Rigid brackets, pivot bracket &amp; self-tapping screws</p>
 <p><b>Din Rail</b>  <b>DIN 6-IMP</b> - 2 rails, 4 screws</p>	 <p><b>Pole Mounting Kit</b>  <b>PMKG-26-IMP</b> - 2" pole  <b>PMKG-36-IMP</b> - 3" pole  <b>PMKG-46-IMP</b> - 4" pole  <b>PMKG-126-IMP</b> - 12" pole</p>	 <p><b>Cord Grips</b>  IP68/NEMA 4X/6P rated  See page 78 for more details.</p>